

If you have any questions/comments, or need any help, feel free to contact us:

**All India Institute of Speech and Hearing,**  
Manasagangothri,  
Mysore- 570 006

**Ph. No :** (0821)-2514449, 2514618

**Fax :** 0821-2510515

**Email :** aiish\_dir@yahoo.com

**Working hours :** 9.00 am to 5.30 pm- Monday to Friday  
(Except on Central Govt Holidays)

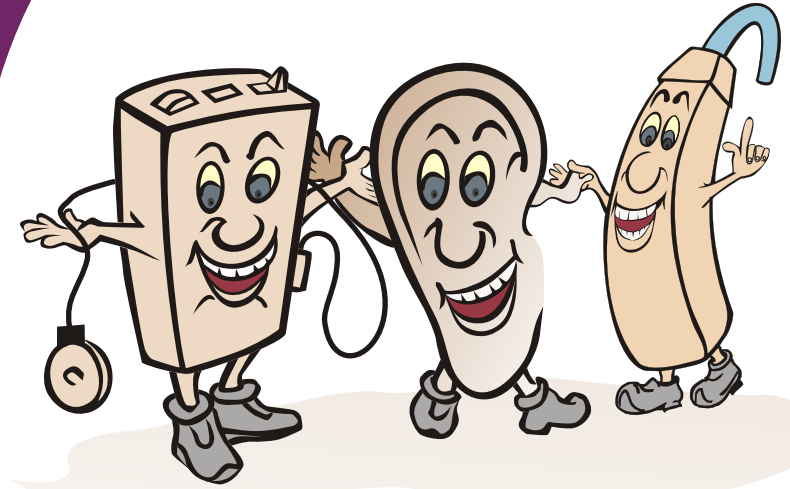

## Getting to know your hearing aid



**ALL INDIA INSTITUTE OF SPEECH AND HEARING**  
Manasagangothri, Mysore - 570 006

# Getting to know your hearing aid

This pamphlet will help you know the controls on your hearing aid as well as the spares required for it.

**User's Name :**

**Case No :**

**Age :**

**Sex :**

**Date when hearing aid was acquired :**

It is recommended that the hearing aid be used for



1. Right ear only



2. Left ear only



3. Left ear or Right ear



4. Both ears

Spares other than the ones recommended may be used only after consulting the audiologist.

Do not exchange the spares of one hearing aid with the other.

For that matter, the hearing aid should not be exchanged indiscriminately without consulting the audiologist.

If you know the details regarding your hearing aid, you should be able to answer the following questions :

- 1) How will you identify your hearing aid?
- 2) Why should you know the serial number of your hearing aid?
- 3) How will you identify your hearing aid receivers?
- 4) Which type of cord do you require for your hearing aid?
- 5) Which type of cells can you use for your hearing aid?
- 6) At what setting should you keep the volume control and tone control switches?



There are different types and models of hearing aids. Note the type and model of the hearing aid recommended for you.

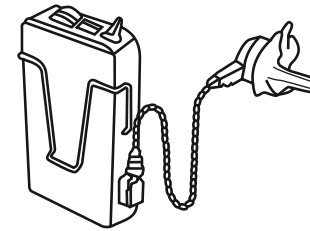

Pocket hearing aid

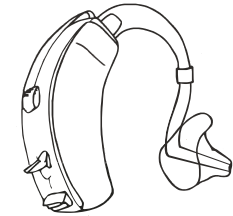

Behind-the-ear-aid

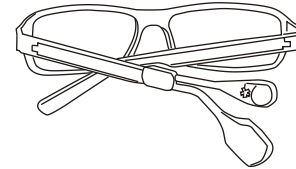

Spectacle hearing aid

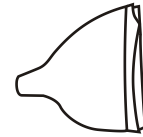

In-the-ear-aid

Model of the hearing aid :

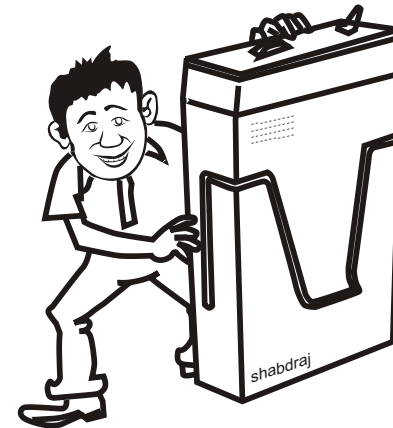

Your hearing aid model.....

Note the serial number of your hearing aid so as to identify yours amongst others of the same type and model.

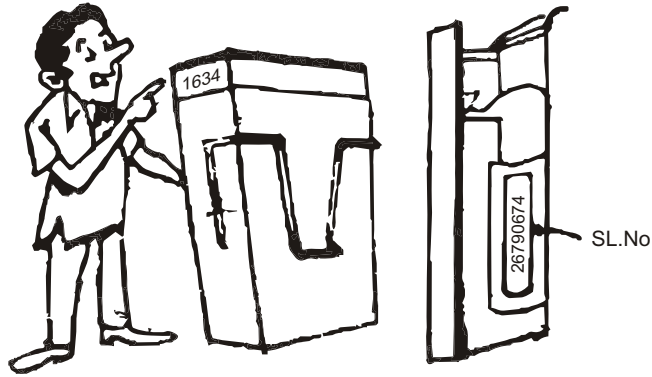

Serial number of your hearing aid.....

The information pertinent to hearing aid type, model and serial number will help you in at least four ways.

1. In the identification of your/your child's hearing aid in the event of loss / theft



Earmolds made for .....

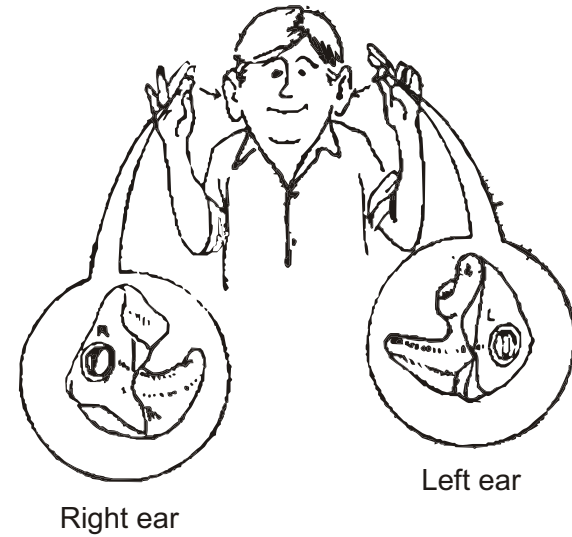

You must always use the earmolds along with the hearing aid. The following diagram will help you connect the hearing aid, cord, receiver and earmold.

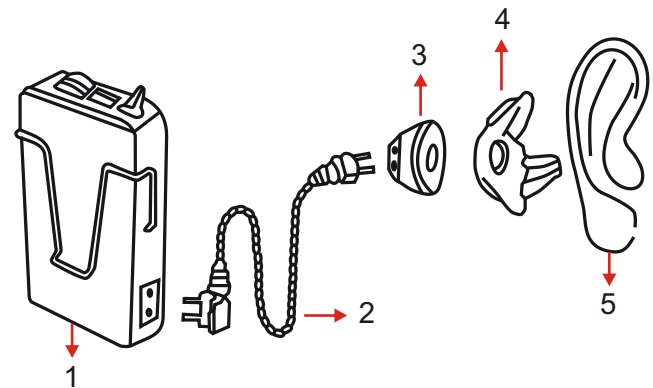

1. Hearing aid
2. Cord
3. Receiver
4. Ear mold
5. Ear

- i) Your receiver type .....
- ii) Its mark and symbol .....

Such information would guide you in the purchase of suitable receivers for your hearing aid. It would also assure that the same receivers are returned after repair of the hearing aid.

Maintain a record of the following when you give your hearing aid for repair/service :

- Date :
- Place :
- Cost :

Using receivers other than those recommended would result in poor clarity due to mismatch.

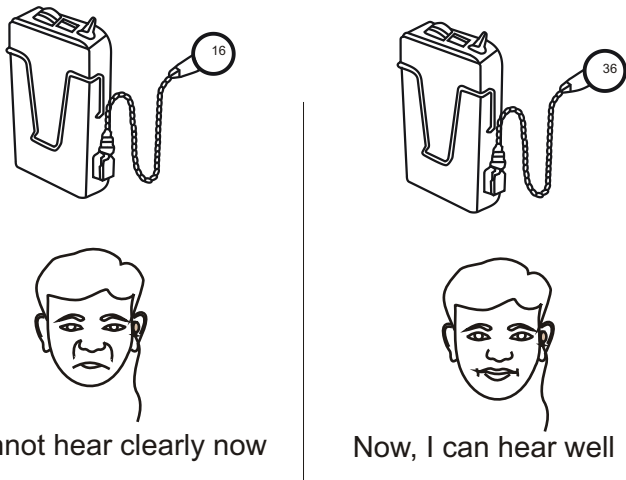

You may also purchase the same type of spares when essential



2. To ensure that you receive the same hearing aid after repair



3. To identify an individual's hearing aid if there are more than one hearing aid user in the family.

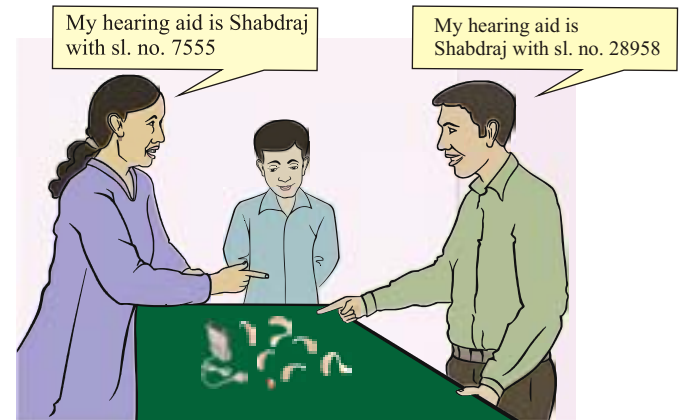

4. It will also enable you to give complete information regarding your hearing aid to the audiologist.

Find the different parts of your hearing aid :

- |                   |                       |
|-------------------|-----------------------|
| 1-Volume Control  | 6-Receiver            |
| 2-Microphone grid | 7-Earmold             |
| 3-On/Off Switch   | 8-Battery Compartment |
| 4-Cord pin        | 9-Clip                |
| 5-Cord            | 10-Socket             |

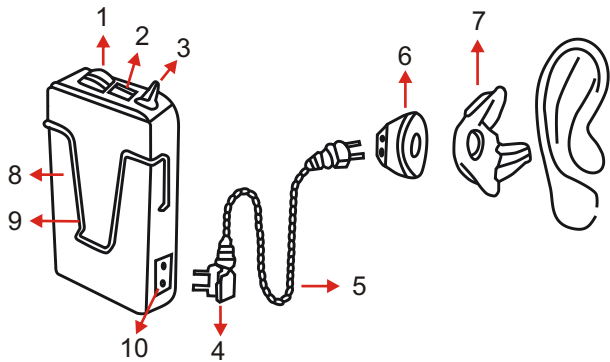

Recommended volume control setting .....

Tone control setting .....

Information regarding the type of spares recommended is of importance to hearing aid users, especially for purchase purposes.

**1) Cord**

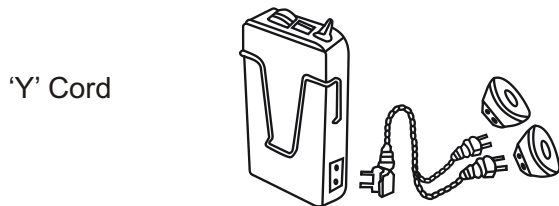
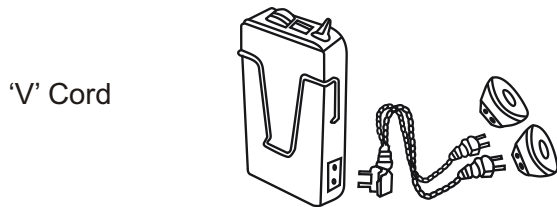
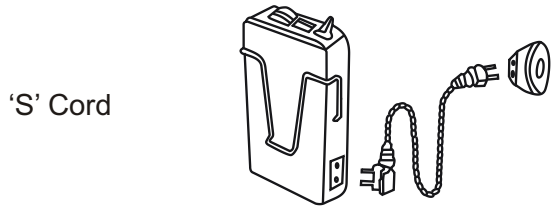

Type of cord recommended for your hearing aid :

i) Single cord/V cord/Y cord.

ii) 2 pin



← 3 pin

**2) Cell**



Pentorch cell

Cell recommended for your hearing aid :

i) Voltage 1.5 volts

ii) Name : .....

**3) Receiver**

Number ←

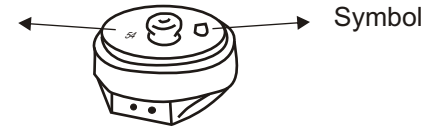

→ Symbol

Air conduction receiver



Bone conduction receiver